

MAXIM

Fast Buffer Amplifier

LH0033A/0033

General Description

The LH0033A and LH0033 are high speed JFET input voltage follower/buffers designed to provide high current drive at frequencies from DC to over 100 MHz. With a slew rate of 1500 V/ μ sec when driving 1k Ω loads, the LH0033 will provide 100 mA output drive (250 mA peak), and can drive loads as low as 50 Ω . In addition, phase linearity is characterized up to 20 MHz for video applications. Specifications are included for driving heavy coaxial cable loads not only at the normal 15 volt supplies, but also for 5V supplies.

The LH0033 family is intended to fulfill a wide range of buffer applications such as high-speed line drivers, video impedance transformation, nuclear instrumentation amplifiers, operational amplifier isolation buffers for driving reactive loads and high input impedance buffers for high-speed analog to digital converters and comparators.

Guaranteed operation over temperature of the LH0033 family is achieved by using specially selected junction field effect transistors along with state-of-the-art active laser trim techniques. They are available in the industry standard hermetic 12 Lead TO-8 metal Can.

Applications

Fast Sample/Hold Amplifiers
Flash A/D Input Buffering
Video Distribution
CRT Drive
Coaxial Line Driver

Pin Configuration

Top View

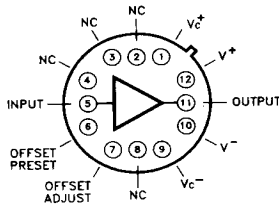

Features

- ◆ Improved 2nd Source! (See 3rd page for "Maxim Advantage™").
- ◆ Guaranteed operation at $\pm 5V$ supplies
- ◆ 1500 V/ μ s Slew Rate
- ◆ 100 MHz Bandwidth
- ◆ 2.9 ns Rise and Fall Times
- ◆ 10¹¹ Ω Input Impedance
- ◆ $\pm 5V$ to $\pm 18V$ Supply Operation

Ordering Information

PART	TEMP. RANGE	PACKAGE
LH0033AG	-55°C to +125°C	12 Lead TO-8
LH0033ACG	-25°C to +85°C	12 Lead TO-8
LH0033G	-55°C to +125°C	12 Lead TO-8
LH0033CG	-25°C to +85°C	12 Lead TO-8

Typical Operating Circuit

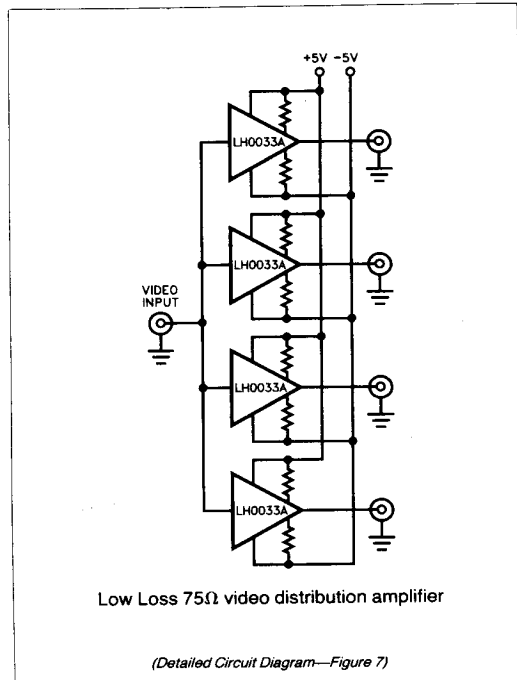

5

The "Maxim Advantage™" signifies an upgraded quality level. At no additional cost we offer a second-source device that is subject to the following: guaranteed performance over temperature along with tighter test specifications on many key parameters; and device enhancements, when needed, that result in improved performance without changing the functionality.

MAXIM

Maxim Integrated Products 5-85

MAXIM is a registered trademark of Maxim Integrated Products.

Fast Buffer Amplifier

ABSOLUTE MAXIMUM RATINGS

Supply Voltage ($V^+ - V^-$)	40V	Peak Output Current	LH0033A/LH0033AC/LH0033/LH0033C	± 250 mA
Maximum Power Dissipation (See Curves)		Operating Temperature Range	LH0033A/LH0033	-55°C to $+125^\circ\text{C}$
LH0033A/LH0033AC/LH0033/LH0033C	1.5W	LH0033AC/LH0033C		-25°C to $+85^\circ\text{C}$
Maximum Junction Temperature	175°C	Storage Temperature Range		-65°C to $+150^\circ\text{C}$
Input Voltage	$\pm V_S$	Lead Temperature (Soldering, 10 seconds)		$+300^\circ\text{C}$
Continuous Output Current				
LH0033A/LH0033AC/LH0033/LH0033C	± 100 mA			

DC ELECTRICAL CHARACTERISTICS

$V_S = \pm 15\text{V}$, $T_{\text{MIN}} \leq T_A \leq T_{\text{MAX}}$ unless otherwise specified (Note 1)

Parameter	Conditions	LH0033A			LH0033AC			LH0033			LH0033C			Units
		Min	Typ	Max	Min	Typ	Max	Min	Typ	Max	Min	Typ	Max	
Output Offset Voltage	$R_S = 100\Omega$, $T_J = 25^\circ\text{C}$, $V_{\text{IN}} = 0\text{V}$ (Note 2) $R_S = 100\Omega$		1	5		6	15		5.0	10		12	20	mV
				10			20						25	mV
Offset Tempco	$R_S = 100\Omega$, $V_{\text{IN}} = 0\text{V}$ (Note 3)		50	100		50	100		50	100		50	100	$\mu\text{V}/^\circ\text{C}$
Input Bias Current	$V_{\text{IN}} = 0\text{V}$ $T_J = 25^\circ\text{C}$ (Note 2) $T_A = 25^\circ\text{C}$ (Note 4) $T_J = T_A = T_{\text{MAX}}$			100			250			250			500	pA
				1.5			2.5			2.5			5.0	nA
				7.5			10			10			20	nA
Voltage Gain	$V_O = \pm 10\text{V}$, $R_S = 100\Omega$, $R_L = 1.0\text{k}\Omega$	0.97	0.98	1.00	0.96	0.98	1.00	0.97	0.98	1.00	0.96	0.98	1.00	V/V
Input Impedance	$R_L = 1.0\text{k}\Omega$	10^{10}	10^{11}		10^{10}	10^{11}		10^{10}	10^{11}		10^{10}	10^{11}		Ω
Output Impedance	$V_{\text{IN}} = \pm 1.0\text{V}$, $R_L = 1.0\text{k}\Omega$		6.0	10		6.0	10		6.0	10		6.0	10	Ω
Output Voltage Swing	$V_I = \pm 14\text{V}$, $R_L = 1.0\text{k}\Omega$ $V_I = \pm 10.5\text{V}$, $R_L = 100\Omega$, $T_A = 25^\circ\text{C}$	± 12			± 12			± 12			± 12			V
		± 9.0			± 9.0			± 9.0			± 9.0			V
Supply Current	$V_{\text{IN}} = 0\text{V}$ (Note 5)		20	22		21	24		20	22		21	24	mA
Power Consumption	$V_{\text{IN}} = 0\text{V}$		600	660		630	720		600	660		630	720	mW

Note 1: LH0033A and the LH0033 are 100% production tested as specified at 25°C , 125°C , and -55°C . LH0033AC and LH0033C are 100% production tested at 25°C only. Specifications at temperature extremes are verified by sample testing, but these limits are not used to calculate outgoing quality level.

Note 2: Specification is at 25°C junction temperature due to requirements of high speed automatic testing. Actual values at operating temperature will exceed the value at $T_J = 25^\circ\text{C}$. When supply voltages are $\pm 15\text{V}$, no-load operating junction temperature may rise 40 – 60°C above ambient, and more under load conditions. Accordingly, V_{OS} may change one to several mV, and I_B will change significantly during warm-up. Refer to I_B vs temperature graph for expected values.

Note 3: LH0033A and LH0033 are 100% production tested for this parameter. LH0033AC and LH0033C are sample tested only. Limits are not used to calculate outgoing quality levels. $\Delta V_{\text{OS}}/\Delta T$ is the average value calculated from measurements at 25°C and T_{MAX} .

Note 4: Measured in still air 7 minutes after application of power. Guaranteed through correlated automatic pulse testing.

Note 5: Guaranteed through correlated automatic pulse testing at $T_J = 25^\circ\text{C}$.

Note 6: Not 100% production tested; verified by sample testing only. Limits are not used to calculate outgoing quality level.

The electrical characteristics above are a reproduction of a portion of National Semiconductor Corporation's copyrighted (1994) Linear data book supplement. This information does not constitute any representation by Maxim that NSC's products will perform in accordance with these specifications. The "Electrical Characteristics Table" along with the descriptive excerpts from the original manufacturer's data sheet have been included in this data sheet solely for comparative purposes.

Fast Buffer Amplifier

- ◆ Full DC specifications at $\pm 5V$ supplies
- ◆ Guaranteed Offset Adjust Range
- ◆ Low Input Capacitance
- ◆ 75Ω load specifications
- ◆ Maxim Quality and Reliability

LH0033A/0033

5

ABSOLUTE MAXIMUM RATINGS: This device conforms to the Absolute Maximum Ratings on adjacent page.

DC ELECTRICAL CHARACTERISTICS Specifications below satisfy or exceed all "tested" parameters on adjacent page.

$V_S = \pm 15V, T_{MIN} \leq T_A \leq T_{MAX}$ unless otherwise specified (Note 1)

Parameter	Conditions	LH0033A			LH0033AC			LH0033			LH0033C			Units
		Min	Typ	Max	Min	Typ	Max	Min	Typ	Max	Min	Typ	Max	
Output Offset Voltage (Note 2)	$R_S = 100\Omega, T_J = 25^\circ C, V_{IN} = 0V$ $R_S = 100\Omega, V_{IN} = 0V$	1	5	10	6	15	20	5	10	15	12	20	25	mV
Offset Tempco	$R_S = 100\Omega, V_{IN} = 0V$ (Note 3)	50	100		50	100		50	100		50	100		$\mu V/^\circ C$
Input Bias Current	$V_{IN} = 0V, T_J = 25^\circ C$ (Note 2) $T_A = 25^\circ C$ (Note 4) $T_J = T_A = T_{MAX}$		100			250			250			500		pA
			1.5			2.5			2.5			5.0		nA
			7.5			10			10			20		nA
Voltage Gain	$V_O = \pm 10V, R_S = 100\Omega, R_L = 1k\Omega$ $V_{IN} = \pm 10.5V, R_S = 100\Omega, R_L = 100\Omega$ $V_{IN} = \pm 2V, R_S = 100\Omega, R_L = 75\Omega$	0.97	0.98	1.00	0.96	0.98	1.00	0.97	0.98	1.00	0.96	0.98	1.00	V/V
		0.86	0.95	1.00	0.86	0.95	1.00							V/V
		0.84	0.95	1.00	0.84	0.95	1.00							V/V
Input Impedance	$V_{IN} = \pm 1V, R_L = 1k\Omega, T_A = 25^\circ C$	10^{10}	10^{11}		10^{10}	10^{11}		10^{10}	10^{11}		10^{10}	10^{11}		Ω
Output Impedance	$V_{IN} = \pm 1V, R_L = 1k\Omega$	6	10		6	10		6	10		6	10		Ω
Output Voltage Swing	$V_{IN} = \pm 14V, R_L = 1k\Omega$ $V_{IN} = \pm 10.5V, R_L = 100\Omega, T_A = 25^\circ C$	± 12			± 12			± 12			± 12			V
		± 9			± 9			± 9			± 9			V
External Offset Resistance	$V_{OS} = 0mV, T_A = 25^\circ C$ (Note 7)	0	75	200	0	75	200							Ω
Supply Current (Note 5)	$V_{IN} = 0V$	20	22		21	24		20	22		21	24		mA
Power Consumption	$V_{IN} = 0V$	600	660		630	720		600	660		630	720		mW

DC ELECTRICAL CHARACTERISTICS

$V_S = \pm 5V, T_{MIN} \leq T_A \leq T_{MAX}$ unless otherwise specified.

Parameter	Conditions	LH0033A			LH0033AC			LH0033			LH0033C			Units
		Min	Typ	Max	Min	Typ	Max	Min	Typ	Max	Min	Typ	Max	
Output Offset Voltage (Note 2)	$R_S = 100\Omega, T_J = 25^\circ C, V_{IN} = 0V$	10	15		12	20								mV
Input Bias Current	$V_{IN} = 0V, T_J = 25^\circ C$ (Note 2) $V_{IN} = 0V, T_A = 25^\circ C$ (Note 4)		100			250			250			500		pA
			300			750			750					pA
Voltage Gain	$V_O = \pm 1V, R_S = 100\Omega, R_L = 1k\Omega$ $V_O = \pm 1V, R_S = 100\Omega, R_L = 75k\Omega$	0.92	0.96	1.00	0.92	0.96	1.00							V/V
		0.84	0.91	1.00	0.84	0.91	1.00							V/V
Input Impedance	$V_{IN} = \pm 1V, R_L = 1k\Omega, T_A = 25^\circ C$	10^{10}	10^{11}		10^{10}	10^{11}								Ω
Output Impedance	$V_{IN} = \pm 1V, R_L = 1k\Omega$	6	10		6	10								Ω
Output Voltage Swing	$V_{IN} = \pm 4V, R_L = 75\Omega, T_A = 25^\circ C$	± 2	± 3.4		± 2	± 3.4								V
Supply Current	$V_{IN} = 0V$	16	20		16	20								mA
Power Consumption	$V_{IN} = 0V$	160	200		160	200								mW

Refer to notes 1-6 on adjacent page.

Note 7: Offset adjust resistor connects between device pin 7 and V — as shown in Figure 2.

Fast Buffer Amplifier

AC ELECTRICAL CHARACTERISTICS

$T_C = 25^\circ\text{C}$, $V_S = \pm 15\text{V}$, $R_S = 50\Omega$, $R_L = 1.0\text{ k}\Omega$ (Note 6)

Parameter	Conditions	LH0033A			LH0033AC			LH0033			LH0033C			Units
		Min	Typ	Max	Min	Typ	Max	Min	Typ	Max	Min	Typ	Max	
Slew Rate	$V_{IN} = \pm 10\text{V}$	1000	1500		1000	1400		1000	1500		1000	1400		V/ μs
Bandwidth	$V_{IN} = 1.0\text{ V}_{\text{rms}}$		100			100			100			100		MHz
Phase Non-Linearity	BW = 1.0 Hz to 20 MHz		2.0			2.0			2.0			2.0		degrees
Rise Time	$\Delta V_{IN} = 0.5\text{V}$		2.9			3.2			2.9			3.2		ns
Propagation Delay	$\Delta V_{IN} = 0.5\text{V}$		1.2			1.5			1.2			1.5		ns
Harmonic Distortion	$f > 1\text{ kHz}$		<0.1			<0.1			<0.1			<0.1		%

Refer to notes 1-7 on second and third page of this data sheet.

The electrical characteristics above are a reproduction of a portion of National Semiconductor Corporation's copyrighted (1984) Linear data book supplement. This information does not constitute any representation by Maxim that NSC's products will perform in accordance with these specifications. The "Electrical Characteristics Table" along with the descriptive excerpts from the original manufacturer's data sheet have been included in this data sheet solely for comparative purposes.

Typical Operating Characteristics

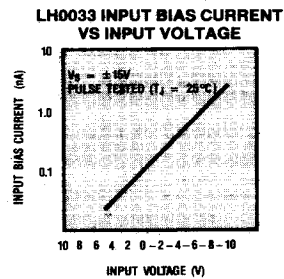
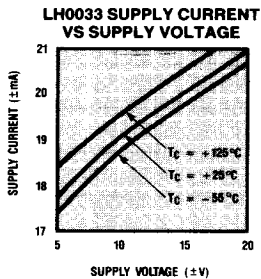
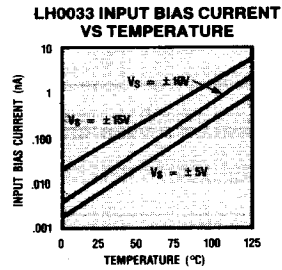
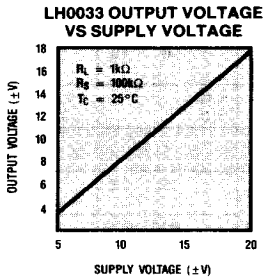

Fast Buffer Amplifier

LH0033A/0033

AC ELECTRICAL CHARACTERISTICS Specifications below satisfy or exceed all "tested" parameters on adjacent page.
 $T_C = 25^\circ\text{C}$, $V_S = \pm 15\text{V}$, $R_S = 50\Omega$, $R_L = 1.0\text{ k}\Omega$ (Note 6)

Parameter	Conditions	LH0033A			LH0033AC			LH0033			LH0033C			Units
		Min	Typ	Max	Min	Typ	Max	Min	Typ	Max	Min	Typ	Max	
Slew Rate	$V_{IN} = \pm 10\text{V}$	1000	1500		1000	1400		1000	1500		1000	1400		$\text{V}/\mu\text{s}$
Bandwidth	$V_{IN} = 1.0\text{ Vrms}$		100			100			100			100		MHz
Phase Non-Linearity	$\text{BW} = 1.0\text{ Hz to } 20\text{ MHz}$		2.0			2.0			2.0			2.0		degrees
Rise Time	$\Delta V_{IN} = 0.5\text{V}$		2.9			3.2			2.9			3.2		ns
Propagation Delay	$\Delta V_{IN} = 0.5\text{V}$		1.2			1.5			1.2			1.5		ns
Harmonic Distortion	$f = 1\text{kHz}$		<0.1			<0.1			<0.1			<0.1		%

Refer to notes 1-7 on second and third page of this data sheet.

Typical Operating Characteristics

LH0033 NORMALIZED INPUT BIAS CURRENT DURING WARM-UP

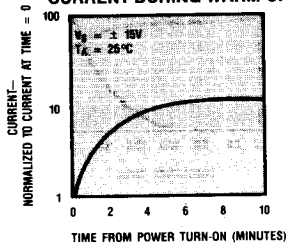

LH0033 NEGATIVE PULSE RESPONSE

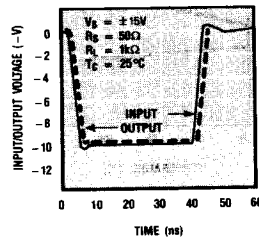

LH0033 POWER DISSIPATION

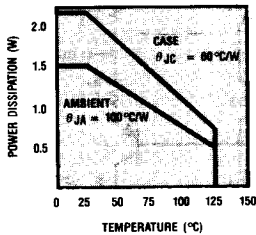

LH0033 POSITIVE PULSE RESPONSE

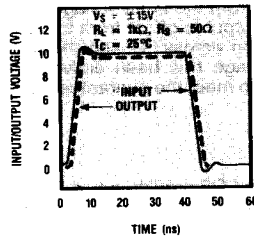

5

Fast Buffer Amplifier

Typical Operating Characteristics

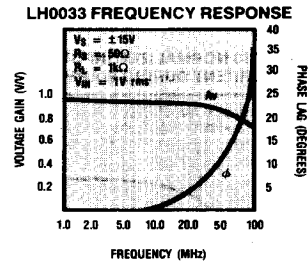
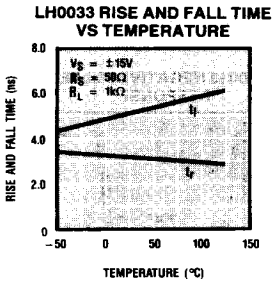
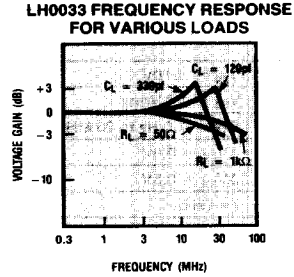
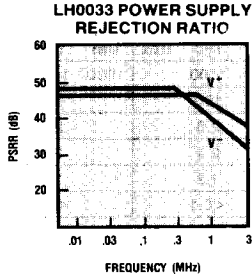

Detailed Description

The LH0033 combines a JFET input stage with a high current bipolar output stage. Also included is the biasing network and laser trimmed resistors for supply current and offset voltage adjustments.

The n-channel JFET Q1 has very low input current, less than 10 nA at $V_{IN} = 0\text{V}$ and $T_J = 125^\circ\text{C}$. The source of Q1 will be offset from the input voltage by the V_{GS} voltage of Q1. The output is offset from the Q1 source voltage by the IR drop across R1 and the V_{BE} of Q5. The output offset voltage has been actively laser trimmed during assembly to meet the guaranteed maximum offset specification.

Transistors Q2 and Q3 provide a two V_{BE} voltage difference between the bases of the two output transistors, setting the quiescent current through Q5 and Q6. Resistors R3 and R4 provide a small amount of degeneration to stabilize the quiescent current over temperature. Q4 is another n-channel JFET, similar to Q1. Q4 acts as a current sink for the current flowing through the input stage (Q1, R1, Q2, and Q3). The voltage drop across diode D1 and resistor R2 is equal to the drop across R1 and the base-emitter junction of Q5.

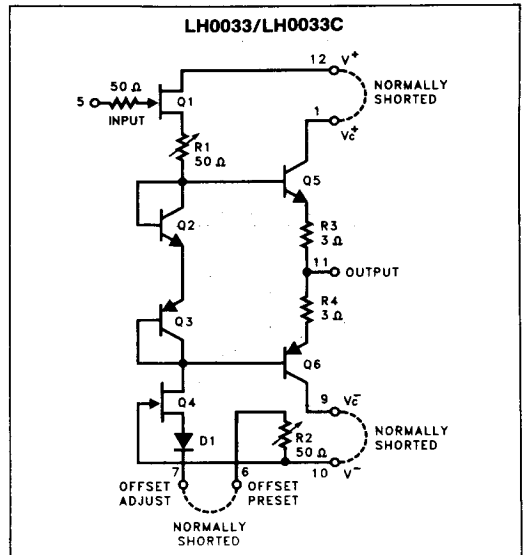

Figure 1. Internal Schematic Diagram

Fast Buffer Amplifier

LH0033A/0033

Since Q2 is matched to Q5 and Q3 is matched to Q6, approximately one-half of the quiescent current flows in the input stage, with the remaining quiescent current flowing through the output transistors. This means that the output stage will be operating as a class A amplifier with output currents less than 10 mA. Above this current, the output stage operates in a class B mode, with slightly increased nonlinearity.

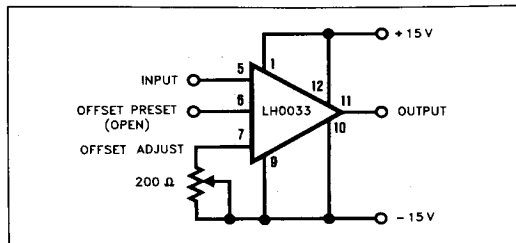

Figure 2. Offset Zero Adjust for LH0033

Applications

Layout Precautions

The LH0033 should be treated as a high frequency amplifier when designing a printed circuit layout. Power supply bypassing to a ground plane with low inductance capacitors should be within a half inch of the device. For applications where the input capacitance is critical, connect the case of the device to the output so that the case capacitance is bootstrapped. For most applications, the case may be left unconnected or grounded. There is no internal connection to the case.

Offset Voltage Adjustment

For most applications, connect pin 6 to pin 7, and the offset voltage will be guaranteed to within the actively trimmed specification. When this is not sufficient, or there is a system offset to be absorbed, an external 200Ω trim pot may be connected from pin 7 to V⁻, as illustrated in Figure 2.

Operation Within an Op Amp Loop

The LH0033 may be used as a current booster within the feedback loop of almost any operational amplifier with only a few cautions: remember that the output is not internally short circuit protected, and many applications will require one of the short circuit protection circuits discussed below.

Short Circuit Protection

The LH0033 is not internally short circuit protected as most of the possibilities involve some compromise in output swing or transient response. The output stage collectors are available separately, however, so there are sev-

eral options open to the user. The simplest and most commonly used is the simple resistor in each output stage collector (Figure 3). For worst case protection these resistors may be calculated by:

$$R_{LIM} = V^+ / 100 \text{ mA} = V^- / 100 \text{ mA} \\ = 150\Omega \text{ for } \pm 15\text{V supplies}$$

Unfortunately, a resistor that large severely restricts the voltage swing into a heavy load and the slew rate into a capacitive load. Decoupling the V_{C+} and V_{C-} pins with capacitors will retain full output swing for transient pulses, but if the capacitors are made too large, (to hold up long pulses) the protection is lost.

An alternative active current limit circuit is shown in Figure 4. This technique retains full DC output swing. The current sources are set to a safe limit and are normally saturated, thus applying full supply voltage to the V_C pins. In the event of a short on the output, the current source comes into operation and reduces the output stage collector voltage as required to keep the current to a safe level. The output stage collectors may be bypassed with a small capacitor to give additional current capacity for short times, as would be required in driving a capacitive load.

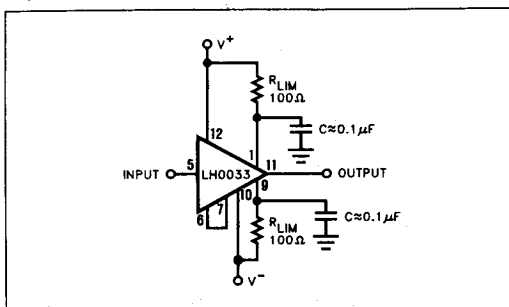

Figure 3. LH0033 Using Resistor Current Limiting

Operation from Single or Asymmetrical Power Supplies

Since the LH0033 has no ground pin, an asymmetrical power supply is indistinguishable from a symmetrical supply with a DC level on the input. (The single supply case is simply the asymmetrical case taken to the extreme of one of the supplies being zero.) In either case, an offset error will be generated corresponding directly to the gain of the circuit times the apparent DC level with respect to a pseudo ground point half-way between the supplies.

$$\text{Offset Voltage} = 0.5(1 - \text{gain})(|V^+| - |V^-|)$$

For example, a device operating on supplies of +5V and -12V would have an apparent offset error due to the gain of about -35 mV. This could be easily corrected with an offset adjust potentiometer connected from pin 6 to V⁻ as discussed in the offset voltage adjustment section.

MAXIM

5-91

5

Fast Buffer Amplifier

Operation from ±5V Power Supplies

The original LH0033 was characterized and guaranteed to operate at ±15 volt power supplies only, but many applications can save substantial power by operating the device from reduced supplies. The Maxim LH0033A and LH0033AC are specified and tested for gain, swing, offset voltage, bias current and supply current at ±5V power supplies as well as the standard ±15V.

Capacitive Loading

The LH0033 is designed to drive heavy capacitive loads without susceptibility to oscillation. Note that the absolute maximum current rating must still be observed, thus the output slew rate times the load capacitance must be less than 250 mA. For example, a 1000 V/μs slew rate with a 250 pF load would fall just within the absolute maximum peak current specification. If a heavier capacitive load needs to be driven, the slew rate must be externally limited.

$$\text{Slew Rate} \leq I_{OUT(MAX)}/C_{LOAD} \leq \pm 250 \text{ mA}$$

Power dissipation resulting from capacitive load currents must be considered independently. The real power dissipated in a circuit driving a sine wave into a pure capacitive load is:

$$P_{AC} = (V_{P,p})^2 \times \text{Frequency} \times C_1$$

This dissipation adds directly to the devices quiescent power and any DC load power that might be present. The sum of all these terms must be less than the absolute maximum power rating at the temperature of operation.

$$P_{DC} + P_{AC} \leq P_{DISS(PKG)}$$

For example, a 250 pF load driven to 20V peak to peak at 1 MHz adds a reactive power dissipation in the LH0033 of:

$$P_{AC} = (20)^2 \times 10^6 \times 250 \times 10^{-12} = 100 \text{ mW}$$

This term is not often a severe application problem with the LH0033.

Power Dissipation Considerations

The LH0033 package is rated for 0.5W in still air at 125°C and 0.75W with an infinite heat sink. Since the quiescent power is in the neighborhood of 600 mW, a heat sink is needed for most 125°C applications and some heavy load applications at lower temperatures. Several suitable commercial heat sinks are available including the Thermalloy 2241, the Wakefield 215CB and the IERC UP-T08-48CB. Please note that the can diameter is 0.55 inches nominal as opposed to the JEDEC TO-8 which is 0.45 inches nominal. (See the outline drawing for detailed dimensions)

Typical Applications

Output Buffer within an Op Amp Loop

The low output impedance, high slew rate, wide power bandwidth, and low phase shift of the LH0033 make it

ideally suited for use as an output buffer for operational amplifiers. When using the LH0033 as an op amp buffer, the total phase shift of both the op amp and the LH0033 buffer must be considered when checking for loop stability. With typically only 10 degrees of phase shift at 50 MHz, the LH0033 can be used with all but the very fastest op amps. With an output impedance of less than 10Ω, the LH0033 can drive large inductive or capacitive loads with little additional phase shift.

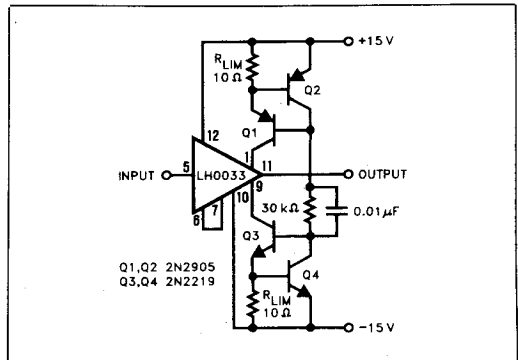

Figure 4. LH0033 Current Limiting Using Current Sources

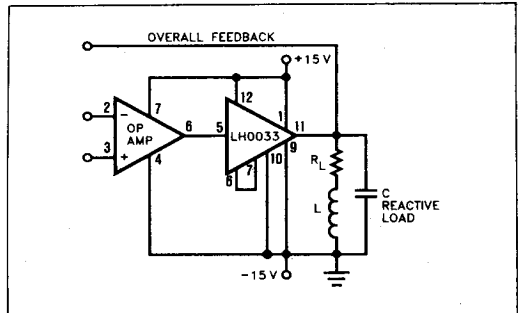

Figure 5. Isolation Buffer

Coaxial Cable Driver

With an input resistance of 10¹¹Ω and input capacitance of 4 pF, the LH0033 places negligible load on a 50 or 75Ω video source. The Maxim LH0033A is guaranteed for operation with ±5V power supplies common in video systems, and is also specified for a minimum ±2V swing into a 75Ω load. The LH0033 typically has only 2 degrees of phase non-linearity over the frequency range of 1 to 20 MHz. The 68Ω resistor on the output can be shorted out if a higher output voltage is required, but this causes a mismeasurement of the 75Ω cable, and reflections will not be absorbed by the coaxial driver output.

Fast Buffer Amplifier

LH0033A/0033

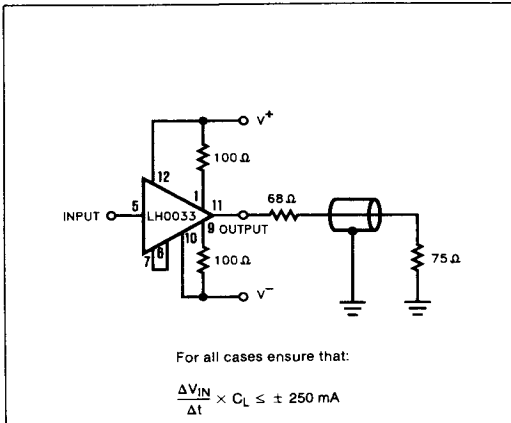

Figure 6. Coaxial Cable Driver

Video Distribution Amplifier

Figure 7 and the front page of this data sheet show a video distribution amplifier capable of driving a number of 75Ω output lines from a single source with very low signal loss. The entire amplifier operates from ±5V supplies with a total power dissipation of 640 mW plus the output power. The input resistance will be in the thousands of megohms and will be negligible in most situations. The input capacitance, however, should be considered as it may result in high frequency mismatches at the input. The voltage gain of the LH0033A and the LH0033AC is specified at 0.91 typ, 0.84 min (±5V supplies and 75Ω load), so the worst case insertion loss of the distribution amplifier is 1.5 dB with a typical under 1dB. Protection resistors are included in series with pins 10 and 12 of each device so that the distribution amplifier will be able to tolerate momentary overloads on the outputs.

Figure 8 is a similar video distribution amplifier which has output resistance of 75Ω to back terminate the outputs. The back termination resistor is selected to be 68Ω to account for the typical 6Ω output resistance of the LH0033. Because each 75Ω load is isolated from the buffer amplifier, each device is able to drive two loads. The voltage loss through this amplifier will be approximately 6 dB. Note that protection resistors are unnecessary in the back terminated configuration, as the LH0033 can safely drive the 68Ω termination resistor even if the cable is shorted.

High Speed Sample/Hold

In Figure 9, the first LH0033 buffers the input and drives the sample capacitor through the FET, Q1, whenever the Sample/Hold logic input is in the sample mode. When the logic input changes to the hold mode, Q1 opens up, isolating the hold capacitor from the input LH0033, and the output voltage no longer follows the input. The sec-

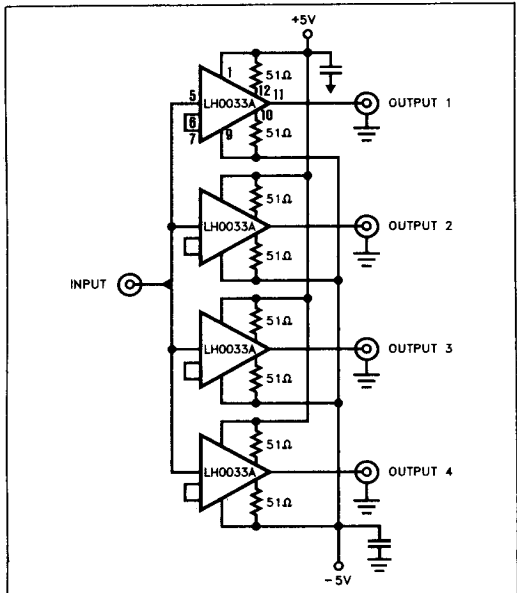

Figure 7. Low Loss 75Ω Video Distribution Amplifier

ond LH0033 buffers and isolates the sample capacitor voltage from the load. Since the input bias current of the LH0033 is typically less than 1 nanoamp, the droop rate of this sample and hold will be less than 1 mV/ms.

Since the LH0033 has a slew rate of 1500 V/μs and a 100 MHz bandwidth, this LH0033-based sample and hold is well suited for use with video speed flash A/D converters.

5

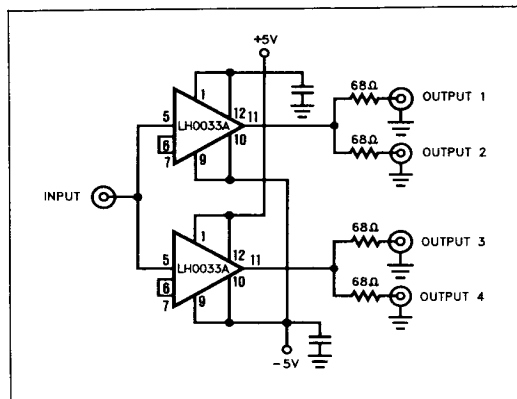

Figure 8. Back Terminated 75Ω Video Distribution Amplifier

Fast Buffer Amplifier

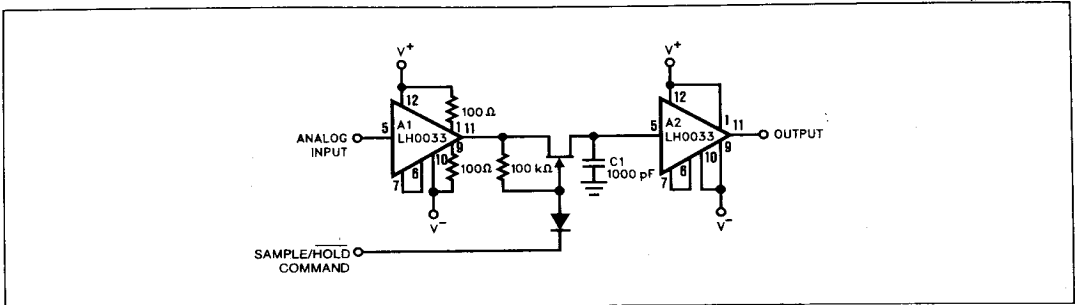

Figure 9. High Speed Sample/Hold

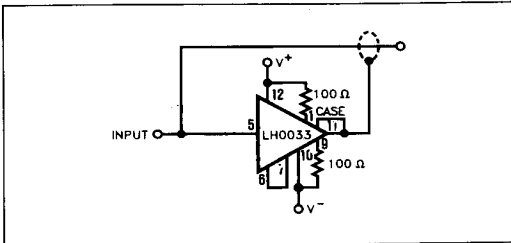

Figure 10. Instrumentation Shield/Line Driver

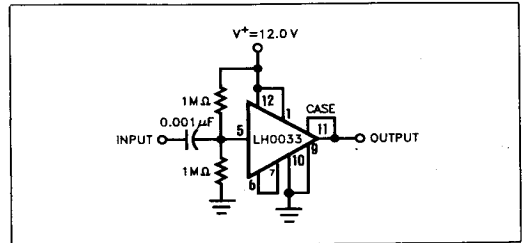

Figure 11. Single Supply AC Amplifier

Maxim cannot assume responsibility for use of any circuitry other than circuitry entirely embodied in a Maxim product. No circuit patent licenses are implied. Maxim reserves the right to change the circuitry and specifications without notice at any time.